

## MULTILEVEL IMAGE FUSION ALGORITHM WITH COMPARATIVE ANALYSIS OF WAVELET AND CURVELET TRANSFORM

Anup Yadav<sup>1</sup>, Mrs. Usha M V<sup>2</sup> (Assistant Professor)  
Information Science and Engineering  
East West Institute of Technology  
Bangalore, Karnataka, India

**Abstract** - Image fusion is a process that combines complimentary information from multiple image into a single image. Image fusion is used in many application like satellite imaging, multifocus imaging, and medical imaging,. Here I have implemented multilevel image fusion in which fusion is takeout in tow stage. Firstly, Discrete wavelet or fast discrete curvelet transform is applied on both source image and secondly image fusion is carried out with either spatial domain methods like Averaging, Minimum selection, maximum selection and PCA or with Pyramid transform methods like Laplacian Pyramid transform. After that, analysis of fused image obtained from both wavelet and curvelet is done 7 quality metrics parameters which that proves curvelet transform is effective image fusion then wavelet transform. The proposed method can be applied to medical and multifocus imaging application in real time and can be helpful for better medical diagnosis.

**Index Terms** - Averaging, AG, Cc, CT, Discrete Wavelet Transform, E, Fast Discrete Curvelet Transform, Image fusion, Image Quality Metrics, Laplacian Pyramid, Maximum Selection, Minimum Selection, MRI, PCA, PSNR, RMSE, SD.

### I. INTRODUCTION

The purpose of image fusion is to combine information from several different source images to one image, which becomes reliable and much easier to be comprehended by people. When the two objects A and B, which have different distance from the same lens, are photographed, it is not often possible to get an image ,that contain the two objects A and B “in focus”. Sometimes the source images have been degraded in different parts. Technology is growing very rapidly and there are many sensors available in the market which provides multimode images with different physical characteristics, geometry, time, frequency domain characteristics. To acquire all these characteristics into a single image is very difficult for sensor. Hence image fusion is a technic which combine all these characteristics into a single image with more information content. Image fusion commonly used term in different application like satellite imaging and remote sensing application many research work has been done but very few attempts are made for medical imaging. Image fusion methods are classified into two domain spatial domain transform domain method and transform domain method.

The spatial domain method includes fusion method namely averaging, principal component analysis (PCA). Spatial domain method has disadvantage that they produce spatial distortion in fused image. By frequency domain we can handle spatial distortion. Transform domain methods include multiresolution Analysis (MRA) such as Pyramid transforms (Laplacian pyramid, gradient pyramid, etc.), Wavelet transforms (Discrete wavelet transform, Multiwavelet transform, Complex wavelet transform, etc.) and Multiscale transforms such as Ridgelet [8], Curvelet and Contourlet. These methods show a better performance in spatial and spectral quality of the fused image compared to other spatial methods of fusion. Most of research work has been done for Medical image fusion, use spatial domain method like averaging, PCA, multiresolution teansforms like Laplacian pyramid transform, Discrete Wavelet transform and multiscale transforms such as curvelet transform. The disadvantage of Laplacian pyramid is that it causes blocking effects in fused image and it also fail for spatial orientation during decomposition process [4,5]. The discrete wavelet transform proves that it is better than pyramid transform because it has better signal to noise ratio and it detect straight edges well, as it operate on point singularity. But discrete wavelet transform has disadvantage it has poor directionality and also fail to represent curvilinear structures[6].curvelet transform is better than wavelet transform because it has high directionality, representing curve like edges efficiently and reduces noise effect[7]. Literature survey for image fusion reveals, mostly all image fusion had been done so far is carried out only at single level but in this paper I have implemented multilevel image fusion in which fusion is carried out in two stages. Also until now in all the research work [3], only one of fusion method, either spatial domain or transform domain is used. Recently, image fusion with single transform and spatial domain are used to improve fusion result [1, 2]. So here in this paper two transform domain methods like Wavelet and Curvelet transform along with five spatial domain methods are used. None of the research paper covers such broad implementation of two different domain methods with comparative performance analysis. Further, the fused image obtained from both Discrete Wavelet and Fast Discrete Curvelet transform are compare by 7 quality metrics parameters, which proves effective image fusion using proposed Curvelet transform than Wavelet transform through enhanced visual quality of fused image and by analysis of 7

quality metrics parameters. The method is modern which carries out complex fusion algorithms at 2-levels which can be used for medical and multi-focus image fusion. I have implemented firstly, transform domain methods which gives high quality spectral contents in fused image. High spatial resolution is also obtained due to spatial domain methods applied at second level. So, the proposed multi-level image fusion method is very innovative which can be applied to medical and multifocus imaging applications in real time. The rest of the paper is organized as follows: Section 2 presents the proposed image fusion algorithm. Section 3 gives the experimental results and comparison of different fusion rules. Finally, section 4 gives the concluding remarks.

## II. THE PROPOSED MULTI LEVEL IMAGE FUSION METHOD

### A. Block Diagram

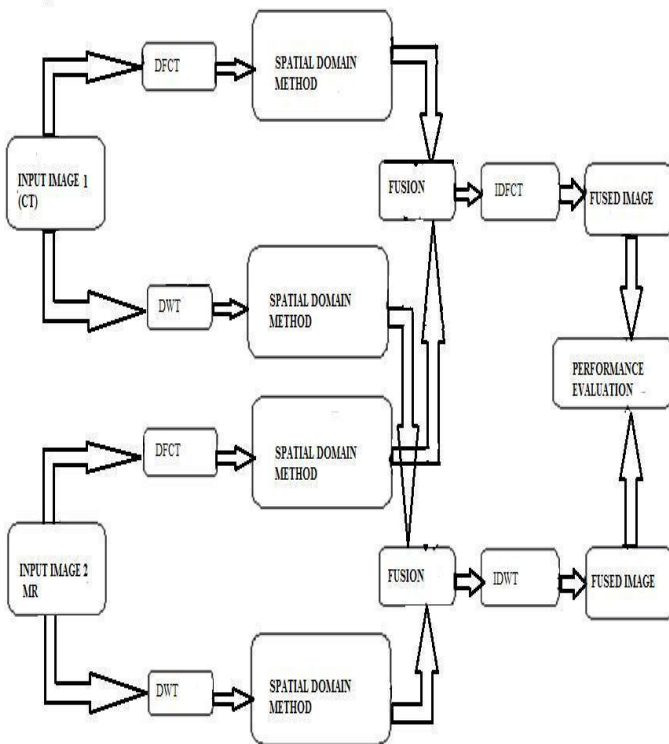

Figure 1: Block diagram of Proposed Method

The Figure 1 represents the block diagram of multi-level image fusion which is carried out in two levels. Two source image, input image 1(CT) and input image 2(MR) are taken as an input images. Image fusion is carried out at 2 stages. Firstly, 2-DWT and FDCT is applied on both the input image which give decomposed wavelet coefficients and decomposed curvelet coefficient respectively at level the 1. Curvelet coefficient is obtained by calculating image orientation from different angles at level 1. The decomposed coefficient from both wavelet and curvelet preserves better information content from source images. And then at second level any of image fusion methods namely Averaging, Minimum selection, Maximum selection, PCA, and

Laplacian pyramid method are applied on both wavelet and curvelet coefficient to get the new wavelet and curvelet coefficients. The new wavelet coefficients obtained of both the images after level 2 are combined together to get fused wavelet coefficients which gives high spatial resolution and high spectral quality contents. Similarly, the new curvelet coefficients obtained of both the images after level 2 are combined together to get fused curvelet coefficients which gives higher spatial resolution and higher spectral quality contents than those obtained from wavelet transform as curvelet transform has high directionality. The final wavelet fused image and curvelet fused image is obtained by applying Inverse Discrete Wavelet transform and Inverse Fast Discrete Curvelet transform on both fused coefficients. Comparative analysis of wavelet fused image and curvelet fused image is done by analysis of 7 quality metrics parameters which proves effective image fusion using Curvelet transform than Wavelet transform.

### B. Multilevel Image Fusion Algorithm

The proposed algorithm is implemented for fused of medical and multifocus imaging application. In medical image CT and MR are of main concern. The CT image contains only bone details and MR image contains soft tissue details. And both CT and MR contain complementary information. If both the image fused the fused image contain bone as well as soft tissue details. The same proposed algorithm is implemented for multifocus image. Images take for different focus such as right and left focus images can be fuse for complementary information.

The steps involved in proposed algorithm can be summarized as follows:

- The two source images CT, image1 [m1,n1] and MR, image2[m2,n2] to be fused are applied as input to system.
- Both the source images are registered and are made of same dimension, 256 x 256. The images of file format namely, .bmp, .jpg, .tif, .gif, .png etc can be read.
- In the proposed multilevel image fusion algorithm the fusion of two source images undergoes into two stages which works as follows.

#### Stage1.

A. The 2D Discrete Wavelet Transform is applied on both the source images using haar transform which undergoes column filtering and then row filtering at 2 levels.

B. The wavelet coefficients from both the source images are obtained which preserves original contents from source images.

C. Similarly, Fast Discrete Curvelet transform with wrapping method is applied to both source images.

D. The FDCT algorithm steps is explained as follows-

- Apply 2D FFT transform to both source image and obtain fourier samples of both images as and where .The obtained frequency samples of both images are periodized.
- The periodization of widowed data is done for each

scale  $s$  and angle  $a$ , form the product for source image  $X[i1,i2]$  as

$$D1[i1,i2]=Us,a=[i1,i2]X[i1,i2] \quad (1)$$

And source image  $Y[i1,i2]$  as

$$D2[i1,i2]=Us,a[i1,i2]Y[i1,i2] \quad (2)$$

- The obtained window data  $D1[i1,i2]$  and  $D2[i1,i2]$  are wrapped around the origin to restrict the rectangular window length  $L1,a * L2,a$  near the origin. The product obtained is

$$Xs,a[i1,i2]=W(Us,aX)[i1,i2] \quad (3)$$

$$Ys,a[i1,i2]=W(Us,aY)[i1,i2] \quad (4)$$

Where dimensions must be in range  $0 \leq i1 < L1,a, 0 \leq i2 < L2,a$

- Hence, the wrapping transformation is a simply reindexing of data.
- Apply the inverse 2D FFT to each  $Xs,a$  and  $Ys,a$
- The curvelet coefficients,  $Xs,a$  and  $Ys,a$  of both the source images which are obtained contains high directionality.

Stage2.

- The different image fusion methods based on spatial and pyramid transform are applied on obtained wavelet and curvelet coefficients from stage 1.
- The spatial and Laplacian pyramid transform methods used are discussed as follows

A. For Minimum selection rule, fusion is done by taking the minimum valued pixels from  $X(i1,i2)$  and  $Y(i1,i2)$  sub images.

$$Fmin = \min(\min(X(i1,i2), Y(i1,i2))) \quad (5)$$

B. In PCA rule, fusion is done with principal component analysis calculation for  $X(i1,i2)$  and  $Y(i1,i2)$  sub images and then integrating product of principal components (PI ,PII ) with each source sub images into a single image.

$$FPCA = PI(X(i1,i2)) + PII(Y(i1,i2)) \quad (6)$$

C. Averaging Rule, fusion is done by taking the average of pixels values from coefficients matrix obtained after DWT and DFCT applied on two source images, namely  $X(i1,i2)$  and  $Y(i1,i2)$  sub images.

$$FAvg = (X(i1,i2) + Y(i1,i2)) / 2 \quad (7)$$

D. For Laplacian pyramid rule, fusion is done by first filtering the  $X(i1,i2)$  and  $Y(i1,i2)$  sub images and then difference is calculated by expansion or interpolation way and then discrete convolution is performed to reconstruct the fused image,  $Flap$ .

E. For Maximum selection rule, fusion is done by taking the maximum valued pixels from  $X(i1,i2)$  and  $Y(i1,i2)$  both sub images of source images.

$$Fmax = \max(\max(X(i1,i2), Y(i1,i2))) \quad (8)$$

Based on the maximum valued pixels between  $X(i1,i2)$  and  $Y(i1,i2)$  sub images, a binary decision map is formulated. Eq. (9) gives the decision rule  $Dr$  for fusion of DWT and FDCT obtained coefficients of two source images.

$$Dr(i,j) = 1, X(i1,i2) > Y(i1,i2) = 0, \text{ otherwise} \quad (9)$$

C. Either spatial or Laplacian pyramid transform method is applied separately to both wavelet coefficients and curvelet coefficients of both the source images which gives two separate new coefficients of wavelet and curvelet transform.

D. Fusion is applied separately on both wavelet and curvelet based new coefficients obtained at level 2.

E. The two concatenated images are obtained based on wavelet and curvelet transform whose coefficients contain both high spatial resolution as well as high spectral quality contents.

F. Apply Inverse 2D Discrete Wavelet transform (IDWT) and Fast Discrete Curvelet Transform (IDFCT) on both the concatenated images based on DWT and FDCT to reconstruct the resultant fused images and display the result.

G. Comparative statistical analysis of fused image obtained from multilevel fusion process based on DWT and DFCT is done with 7 quality metrics parameters such as Mean, Standard deviation, Entropy, Average Gradient, PSNR, RMSE and Corelation Coefficient.

### III. EXPERIMENTAL RESULTS AND STATISTICAL ANALYSIS

The figure 2(I, II, III, IV, V) and figure 3(I, II, III, IV, V) shows the experimental result of proposed algorithm for medical image fusion and multifocus image fusion respectively with different transforms at two levels. Comparison of DWT and FDCT is done by analysis of 7 quality metrics parameters. The 7 quality metrics parameters are mean, Standard deviation, Entropy, Average gradient, PSNR, RMSE and CC. The mean of an image represents the average of pixel values, for better contrast the mean value must be high in an image. Standard deviation represents the deviation of pixel values from mean. The SD must be higher for higher contrast in an image. Entropy (E) is measure of information content in an image, so for higher information content in an image entropy should be higher. Average gradient (AG) represents the clarity or contrast in an image, thus for more clarity in an image the AG value must also be high. The PSNR represents the peak signal to noise ratio, so for less noise in an image the PSNR value must be high. RMSE represents root mean square error, for better fused image the RMSE must be small, so the error in the fused image will be less. The Correlation Coefficient, CC represents correlation of fused image with any of one source images, thus value of CC must be near to one for better fused image. The result of both DWT and FDCT with stage 2 fusion method is compared by statistical analysis of 7 quality metrics parameters and it shows that the laplacian pyramid fusion method with FDCT at stage 2 gives best result for both medical and multifocus fused image than any other method at stage 2.

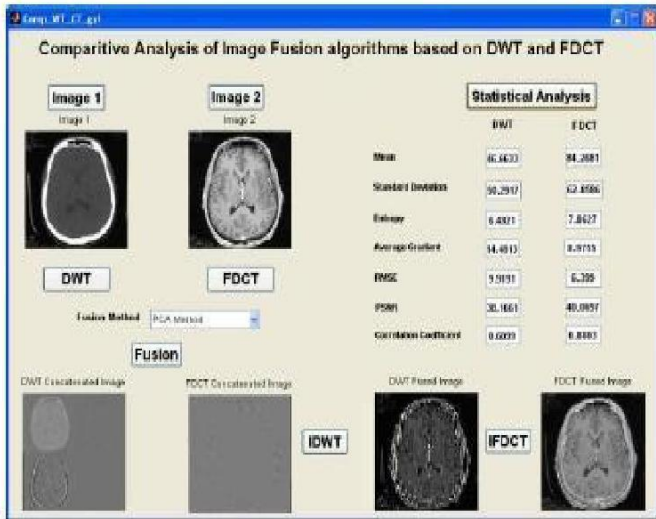

Figure 2(I): Result of Image 1 and Image 2 fused by proposed method with PCA Method.

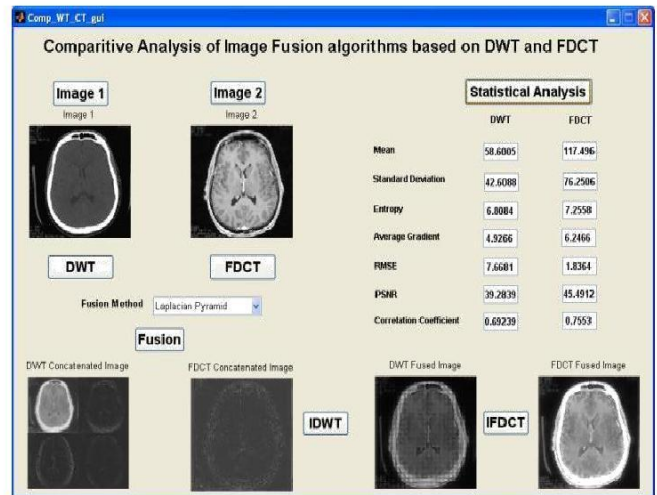

Figure 2(IV): Result of Image 1 and Image 2 fused by proposed method with Laplacian Pyramid.

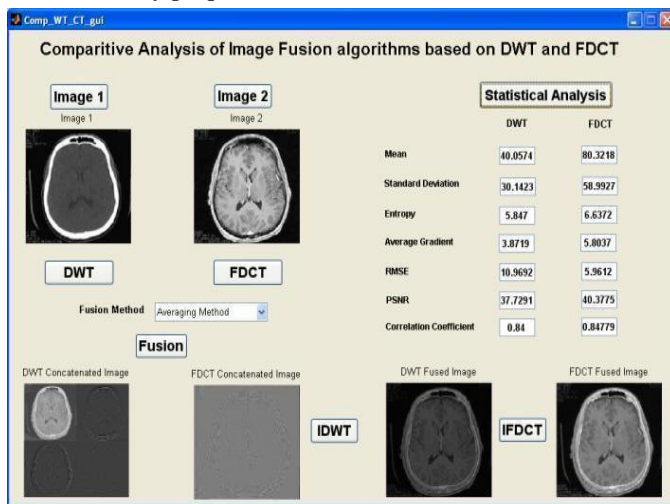

Figure 2(II): Result of Image 1 and Image 2 fused by proposed method with Averaging Method.

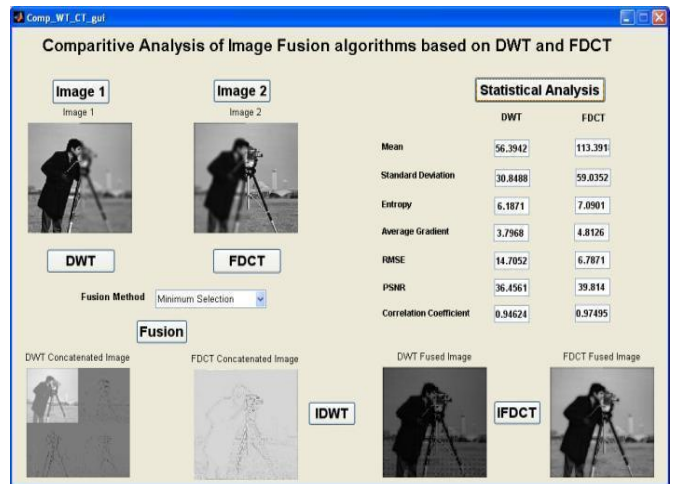

Figure 3(I): Result of Image 3 and Image 4 fused by proposed method with Minimum Selection.

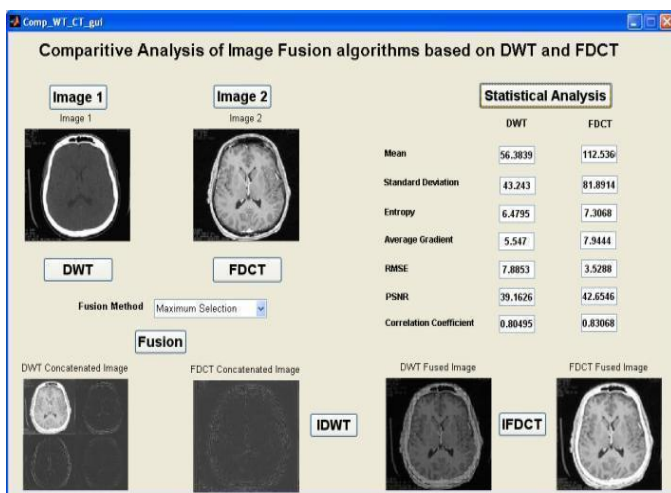

Figure 2(III): Result of Image 1 and Image 2 fused by proposed method with Maximum Selection.

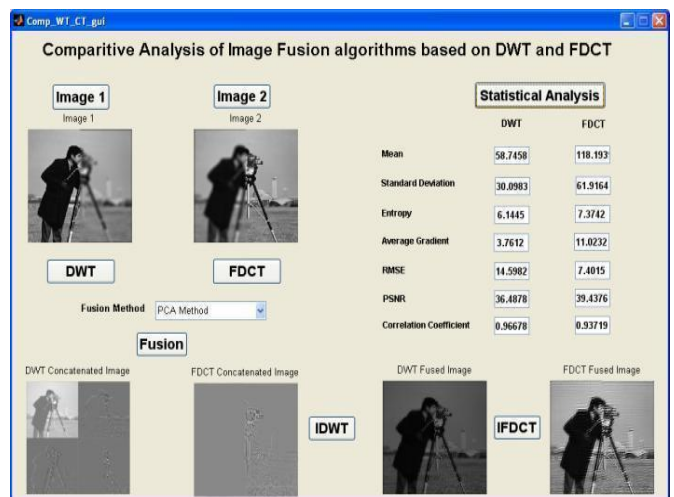

Figure 3(II): Result of Image 3 and Image 4 fused by proposed method with PCA Method.

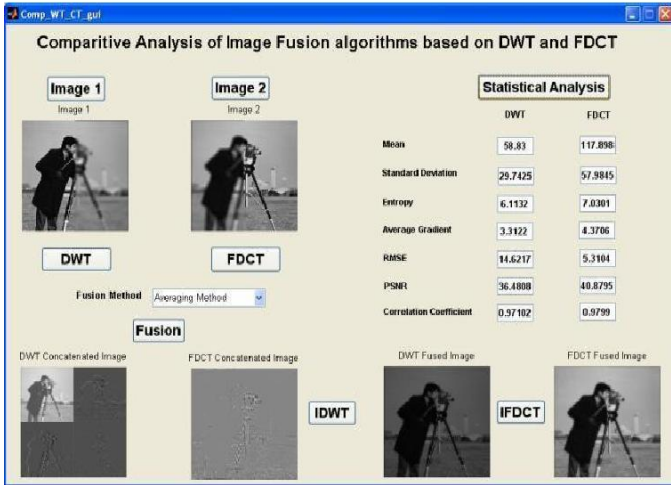
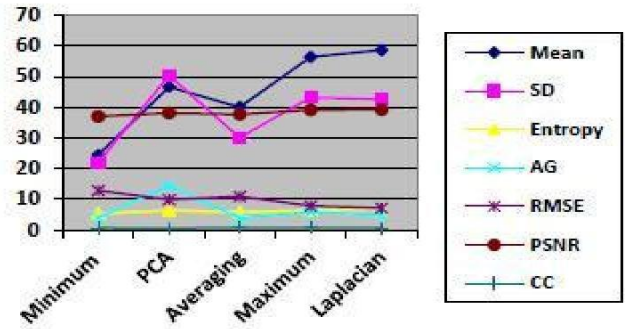

Figure 3(III): Result of Image 3 and Image 4 fused by proposed method with Averaging Method.



Graph 1. Statistical analysis of proposed DWT based multilevel algorithm for medical fused

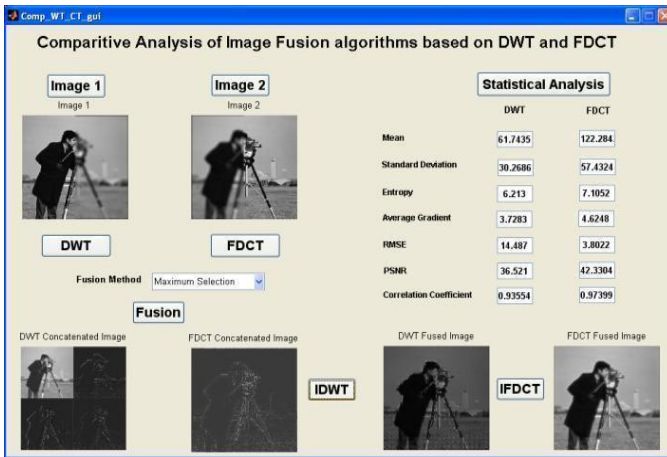
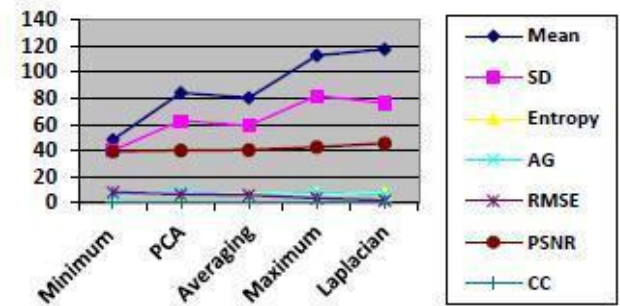

Figure 3(IV): Result of Image 3 and Image 4 fused by proposed method with Maximum Selection.



Graph 2. Statistical analysis of proposed FDCT based multilevel algorithm for medical fused image

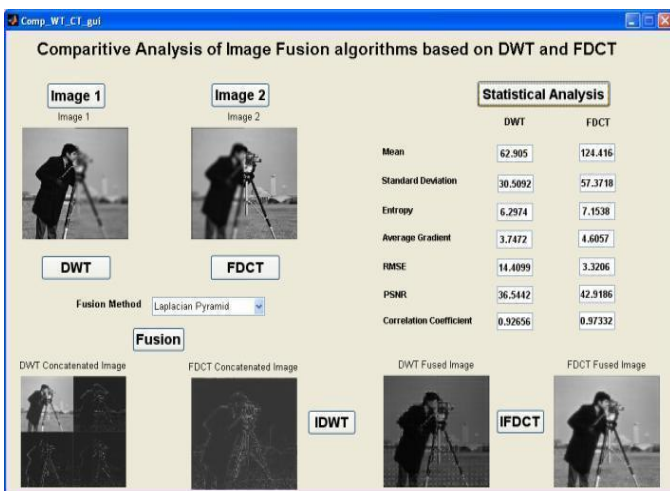
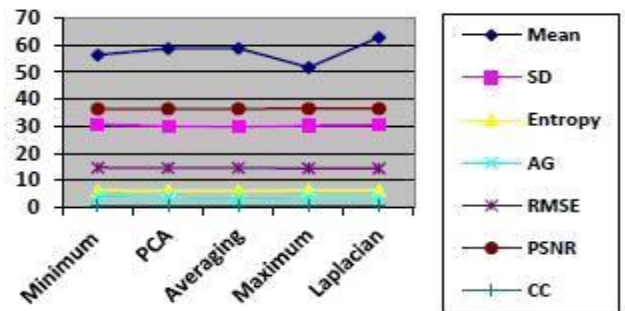
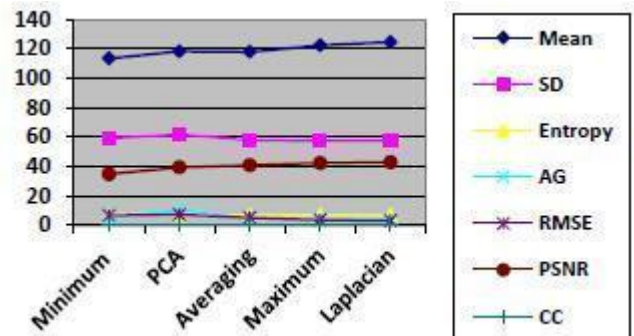

Figure 3(V): Result of Image 3 and Image 4 fused by proposed method with Laplacian Pyramid.



Graph 3. Statistical analysis of proposed DWT based multilevel algorithm for multifocus fused image



Graph 4. Statistical analysis of proposed FDCT based multilevel algorithm multifocus fused image

The above graphs show the comparison of different image fusion methods with DWT and FDCT. Graph 1 shows the Statistical analysis of proposed DWT based multilevel algorithm for medical fused image. Graph 2 shows the Statistical analysis of proposed FDCT based multilevel algorithm for medical fused image. Graph 3 shows the Statistical analysis of proposed DWT based multilevel algorithm for multifocus fused image. And Graph 4 shows the Statistical analysis of proposed FDCT based multilevel algorithm for multifocus fused image. As we can see in all the above graphs, the quality metrics such as mean, SD, E, AG, CC, and PSNR value either increase or remain constant from minimum fusion method to laplacian pyramid fusion method. But RMSE quality metrics value decrease from minimum fusion method to laplacian pyramid fusion method. So the laplacian pyramid fusion method with FDCT at stage 2 gives best result for both medical and multifocus fused image than any other method at stage 2.

#### IV. CONCLUSION

The proposed multilevel image fusion algorithm based on DWT and FDCT works expeditiously for fusion of medical and multifocus imaging applications. In this paper, the comparison of DWT and FDCT is done by tabular and graphical representation which shows improved fusion quality by statistical analysis of 7 quality metrics parameters. The FDCT based multilevel image fusion works better than DWT based multilevel image fusion. But of all the combinations of transforms implemented, the FDCT with Laplacian pyramid transform gives the best fusion result for both medical and multifocus images in terms of enhanced visual quality, richness of information content in fused image, better PSNR and low RMSE value. The proposed algorithm and results obtained can be used by researchers or academicians for further research work on image fusion. The future work includes, implementing other fusion methods based on latest multiscale geometric analysis transform and some improvements in pre as well as post processing of image fusion.

#### REFERENCES

- [1] R.J. Sapkal, S.M. Kulkarni, "Image Fusion based on Wavelet Transform for Medical Application", International Journal of Engineering Research and Applications, Vol. 2, Issue 5, September-October 2012, pp.624-627.
- [2] Abhijit Somnath and Ujwal Harode, "A Novel Approach of Image Fusion based on Wavelet Transform and Curvelet Transform", IJCA Proceedings on International Conference and workshop on Emerging Trends in Technology (ICWET 2012) icwet(4):11-14, March 2012.
- [3] Parmar, Kiran R., "Analysis of CT and MRI Image Fusion Using Wavelet Transform", IEEE Xplore digital library in 2012 International Conference on Communication Systems and Network Technologies (CSNT).
- [4] P. J. Burt, E. H. Adelson, "The Laplacian pyramid as a compact image code," IEEE Transactions on Communications, vol. 31, no. 4, pp. 532–540, 1983.
- [5] P. J. Burt, R. J. Kolczynski, "Enhanced image capture through fusion," in Proc. 4th Internat. Conf. on Computer Vision, pp. 173–182, 1993
- [6] H. Li, B. S. Manjunath, and S. K. Mitra, "Multisensor image fusion using the wavelet transform," Graphical Models and Image Processing, vol. 57, no. 3, pp. 235–245, 1995.
- [7] F. E. Ali, I. M. El-Dokany, A. A. Saad, and F. E. Abd El-Samie, "Fusion of MR and CT Images Using The Curvelet Transform", 25th National Radio Science Conference (NRSC 2008), March 18-20, 2008, Faculty of Engineering, Tanta Univ., Egypt
- [8] E.J. Candes, "Ridgelets: Theory and Applications," USA: Department of Statistics, Stanford University, 1998.
- [9] Shivsubramani Krishnamoorthy, K P Soman, "Implementation and Comparative Study of Image Fusion Algorithms," International Journal of Computer Applications, Volume 9– No.2, November 2010.
- [10] Shih-Gu Huang, "Wavelet for Image Fusion"
- [11] E. J. Candes, L. Demanet, D. L. Donoho et al., "Fast Discrete Curvelet Transforms[R]", Applied and Computational Mathematics. California Institute of Technology, 2005.1.
- [12] Yijian Pei, Jiang Yu, Huayu Zhou and Guanghui Cai, "The Improved Wavelet Transform Based Image Fusion Algorithm and The Quality Assessment", 2010 3rd International Congress on Image and Signal Processing (CISP2010).
- [13] LiHui-hu, GuoLe, LiuHang, "Research on image fusion based on the second generation curvelet transform [J]", Acta Optica Sinica, 2006, 26(5): 657 ~662.