

# REVIEW OF BIDIRECTIONAL DC TO DC CONVERTERS FOR SOLAR PV-WIND-BATTERY BASED HYBRID SYSTEM

<sup>1</sup>Mr. Utkarsh Thakkar, <sup>2</sup>Mr. Darshan Patel

<sup>1</sup>BE Electrical, <sup>2</sup>Assistant Professor

Department of Electrical Engineering

Alpha College of Engineering and Technology, Khatraj, Kalol,  
Gandhinagar, Gujarat, India

**Abstract**— In renewable energy systems, fluctuating outputs from energy sources and variable power demand may deteriorate the voltage quality. In this paper a model predictive control strategy without using any proportional-integral-derivative (PID) regulators is proposed. The proposed strategy consists of a model predictive current and power (MPCP) control scheme and a model predictive voltage and power (MPVP) control method. By controlling the bidirectional dc-dc converter of the battery energy storage system based on the MPCP algorithm, the fluctuating output from the renewable energy sources can be smoothed, while stable dc-bus voltage can be maintained. Meanwhile, the ac/dc interlinking converter is controlled by using the MPVP scheme to ensure stable ac voltage supply and proper power flow between the microgrid and the utility grid. Then, a system-level energy management scheme (EMS) is developed to ensure stable operation under different operation modes by considering fluctuating power generation, variable power demand, battery state of charge (SOC), etc. The Proposed System is simulated using Matlab-Simulink with simulation results analysis.

**Keywords**—PV, MPVP, MPCP, EMS, PID, SOC, etc.

## 1. INTRODUCTION

There are many rural villages in countries around the world that do not have access to electricity. According to International Energy Agency (IEA), more than 1.3 billion people around the world do not have access to electricity. Approximately 84% of these people live in rural villages. Recently, because of the advancement in power electronics, renewable energy sources and energy storage technologies have allowed the cost of led the cost of energy from renewable resources to compete with conventional resources. One of the existing solutions to electrify rural villages is the use of MG energy systems.

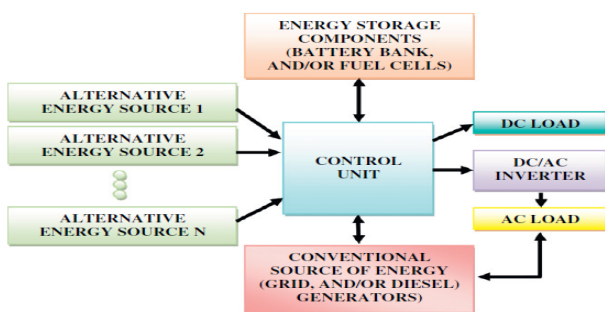

Figure 1.1 General structure of a microgrid system

An MG can be defined as a group of interconnected loads and distributed energy resources within clearly defined electrical boundaries. These resources act as a single controllable entity that connects or disconnects from the grid to enable it to operate in a grid-connected or “island” mode. The hybridization and integration of renewable energy resources for an MG are used to obtain optimal control and energy management. Figure 1.1 shows a block diagram for a MG energy system. Recently, due to the increasing presence of dc power sources in microgrids such as PV, fuel-cell, energy storages, modern dc loads, and considering the existing century-long ac power systems, interests on hybrid ac/dc microgrids are growing rapidly. Traditionally, cascade inner current and outer voltage feedback loop with PID regulators are commonly used to control dc-dc converters and ac/dc interlinking converters in such microgrids. In renewable energy systems, fluctuating outputs from energy sources and variable power demand may deteriorate the voltage quality.

In this paper a model predictive control strategy without using any proportional-integral-derivative (PID) regulators is proposed. The proposed strategy consists of a model predictive current and power (MPCP) control scheme and a model predictive voltage and power (MPVP) control method. By controlling the bidirectional dc-dc converter of the battery energy storage system based on the MPCP algorithm, the fluctuating output from the renewable energy sources can be smoothed, while stable dc-bus voltage can be maintained. Meanwhile, the ac/dc interlinking converter is controlled by using the MPVP scheme to ensure stable ac voltage supply and proper power flow between the microgrid and the utility grid.

## 2. RESEARCH OBJECTIVES

Over recent years several research and investment has been carried out in hybrid power system who recommended an optimal design model for hybrid solar-wind system, which employs battery banks to calculate the system’s optimum configurations in Power system. The different researchers have presented a hybrid solar-wind system as a renewable source of power generation for grid connected application in any country. They also modelled a hybrid solar wind power plant in different countries two-year period using hourly solar irradiation and wind speed data. The limitations of global resources of fossil and nuclear fuel, has necessitated an urgent search for alternative sources of energy. Therefore,

a new way must be found to balance the supply and demand without resorting to coal and gas fuelled generators.

Integration configurations between different energy sources and loads in an MG can be categorized into three possible configurations: AC coupled, DC coupled, and hybrid coupled configuration as shown in Figure 2.1. Each configuration has its own advantages and disadvantages in terms of control complexity, cost, efficiency and reliability.

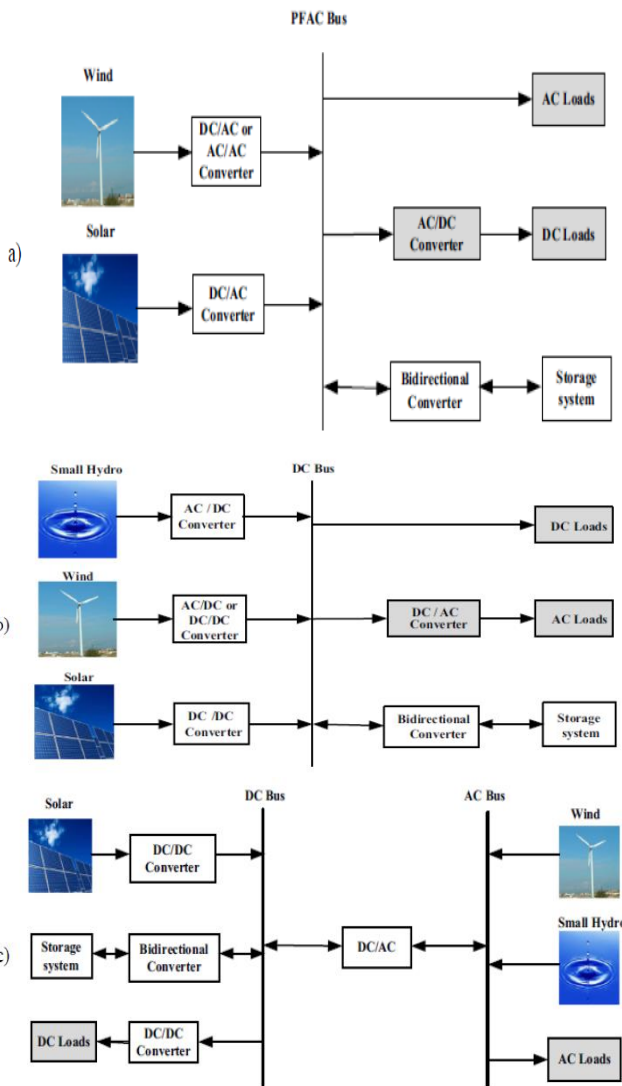

Figure 2.1 Microgrid configurations: a) AC coupled b) DC coupled c) Hybrid coupled

Unit sizing of photovoltaic (PV) panels and wind turbines with energy storage for an islanded MG has been studied by many researchers. The criteria for choosing the optimal size of integrated renewable energy system (IRES) are usually influenced by economic and power reliability factors. There are many methodologies applied to proper unit sizing of an isolated hybrid PV-wind MG system which can be summarized as shown in Figure 2.2 below.

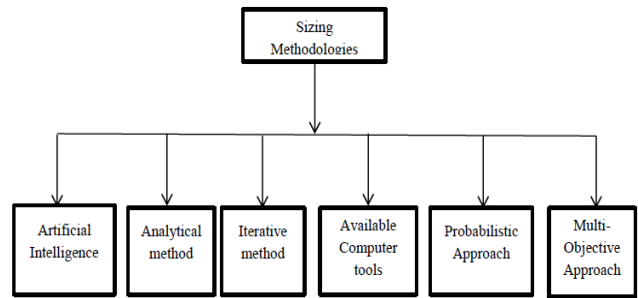

Figure 2.2 Sizing methodologies of IRES

Research Problems...

- For decades, cascade linear control has dominated the power electronic control techniques.
- However, this approach has major drawbacks.
  1. First, the control structure is complicated with multiple feedback loops and PWM modulation, which leads to slow dynamic response.
  2. Second, the tuning of the proportional-integral-differential (PID) parameters is time-consuming, which makes the controller not easy to implement.
- In a practical microgrid, fluctuating output from renewable energy sources can cause oscillations in dc-bus voltage, which in turn, may further deteriorate the power quality on the ac side.

Research Objectives

- In renewable energy systems, fluctuating outputs from energy sources and variable power demand may deteriorate the voltage quality.
- In this paper a model predictive control strategy without using any proportional-integral-derivative (PID) regulators is proposed.
- The proposed strategy consists of a model predictive current and power (MPCP) control scheme and a model predictive voltage and power (MPVP) control method.
- By controlling the bidirectional dc-dc converter of the battery energy storage system based on the MPCP algorithm, the fluctuating output from the renewable energy sources can be smoothed, while stable dc-bus voltage can be maintained.

### 3. PROPOSED WORK

For decades, cascade linear control has dominated the power electronic control techniques. However, this approach has major drawbacks. First, the control structure is complicated with multiple feedback loops and PWM modulation, which leads to slow dynamic response. Second, the tuning of the proportional-integral-differential (PID) parameters is time-consuming, which makes the controller not easy to implement. In a practical microgrid, fluctuating output from renewable energy sources can cause oscillations in dc-bus voltage, which in turn, may further deteriorate the power quality on the ac side. As a result, traditional cascade control may no longer be effective to deal with this fluctuation.

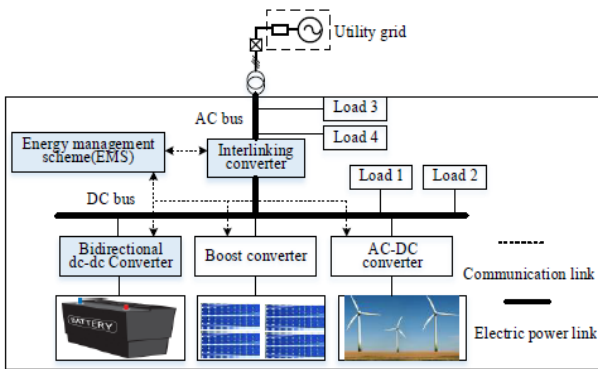

Fig. 3.1 a microgrid with multiples energy sources and converters

Recently, due to the increasing presence of dc power sources in microgrids such as PV, fuel-cell, energy storages, modern dc loads, and considering the existing century-long ac power systems, interests on hybrid ac/dc microgrids are growing rapidly. Traditionally, cascade inner current and outer voltage feedback loop with PID regulators are commonly used to control dc-dc converters and ac/dc interlinking converters in such microgrids. Typically, in islanded mode, the main ac/dc interlinking converter is controlled to provide a stable voltage and frequency for the ac sub grid while the dc-link voltage is maintained by the bidirectional dc-dc converter. In grid-connected mode, the ac/dc interlinking converter is used to maintain a stable dc-link voltage and to exchange power between the microgrid and the utility system. As the dc-dc converters and the ac/dc interlinking converters are vital to ensure stable dc and ac supply, the drawbacks of the conventional cascade control with PID regulators may affect the voltage quality. Another concern is that, in existing microgrid research, the inputs of the distributed inverters are usually connected to ideal dc power sources to simulate a variety of renewable energy resources. For control techniques development of inverters, it is reasonable and sufficient because this assumption can facilitate the design process. From the viewpoint of practical applications, however, the intermittent nature of such energy resources must be considered. Under variable power generation and power demand conditions, the traditional cascade control methods may no longer be effective to deal with this fluctuation. More advanced control methods may be therefore required to ensure stable operation and high power quality.

In this paper a new control strategy based on MPC is developed for renewable energy based microgrids. The topology of the microgrid is shown in Fig. 3.1. The renewable energy resources could be the wind, solar, wave, etc. Here, solar PV system and wind generator are adopted as an example, which is not the main focus in this research. There are two parts in the whole system: DC sub grid with dc loads and ac sub grid with ac loads. The battery energy storage system (BESS) is connected to the dc bus via a dc/dc converter. The ac and dc buses are interconnected through a bidirectional ac/dc interlinking converter which is a three-

phase two-level voltage source inverter (VSI).

#### 4. SIMULATION & RESULTS

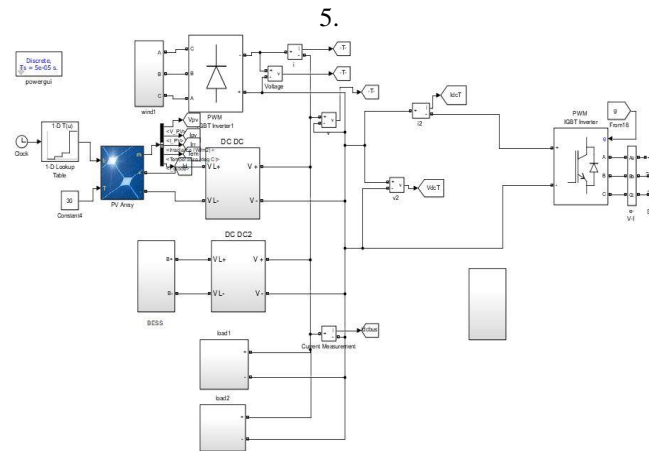

Fig 4.1- Matlab Simulation of A microgrid with multiples energy sources and converters

- In this Paper, a new control strategy based on MPC is developed for renewable energy based microgrids. The topology of the microgrid is shown in Fig. 4.1.
- The renewable energy resources could be the wind, solar, wave, etc.

#### Simulation Results under Grid-connected mode

This mode refers to grid-connected operation. Any power surplus or deficit within the microgrid is automatically balanced by the ac distribution network. In this case, the PV and wind generator should produce as much power as possible for the microgrid and the utility. Also, no load shedding is required and the ESS can be charged or discharged depending on the actual electricity price

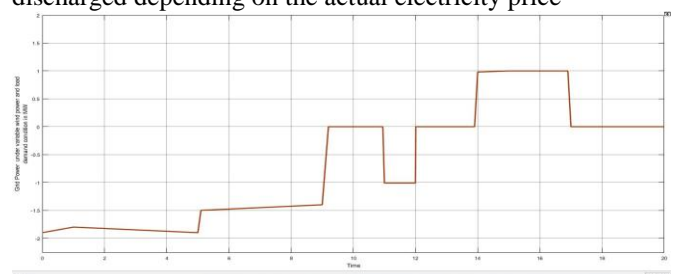

Fig 4.2-Grid Injected Power under load demand Condition in MW

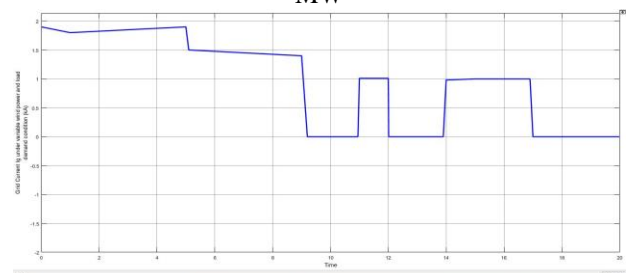

Fig 4.3 Grid Current under load demand Condition in kA

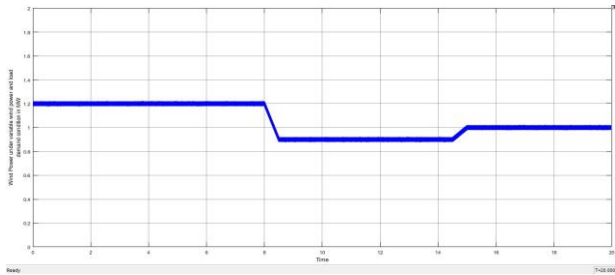

Fig 4.4- Wind Power under load demand Condition in MW

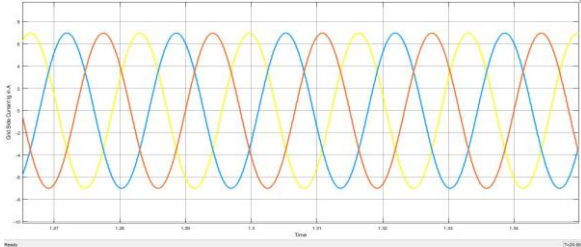

Fig 4.5- Three Phase Grid Current



Fig 4.6- Price per kWh

Simulation Results under Isolated performance under variable PV power and load demand condition

This mode refers to islanded operation. Since the hybrid microgrid becomes an isolated system, the power needs to be balanced within the microgrid. In this case, the dc-bus voltage is maintained by the ESS. The ac-bus voltage is established by the ac/dc interlinking converter using MPVP scheme. Specifically, there are two conditions that need to be considered.

Low wind and irradiation and heavy load

Under this scenario, the generation from PV and wind cannot meet the load demand. As a result, both the PV and wind generator should operate in MPPT while the ESS provides additional power by battery discharging. If the required power by the ESS exceeds the power rating of the battery or the SOC drops down to the minimum value, load shedding becomes necessary to guarantee power supply to the most critical loads

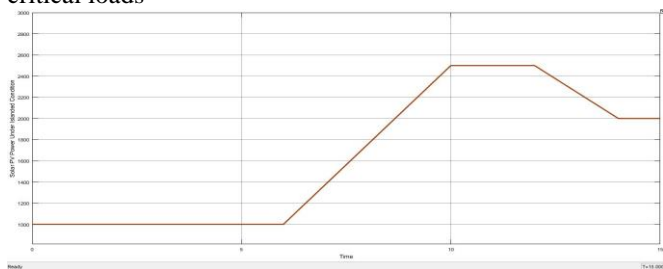

Fig 4.7- Solar PV Power under Isolated Mode in MW

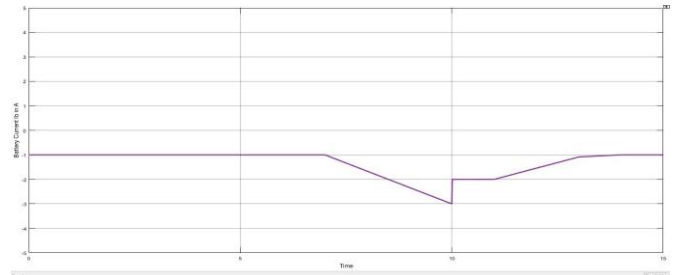

Fig 4.8- Battery Current under Isolated Mode in A High wind and irradiation and light load

Under this circumstance, the generation from PV and wind is greater than the load demand. The ESS is used to absorb the excessive energy by charging the battery. If the power absorbed by the battery exceeds the power rating of the battery or the SOC reaches the maximum value, Off-MPPT operation of the PV and wind systems are needed.

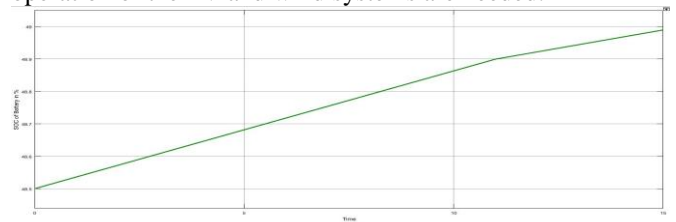

Fig 4.9- SOC of Battery in %

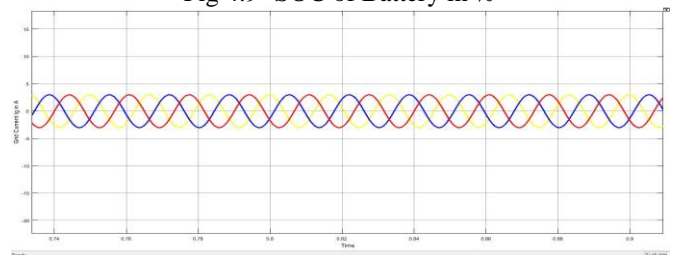

Fig 4.10- Three Phase Grid Current  $I_g$

Simulation Results under Grid synchronization and connection

Existing research seldom mentions the grid synchronization and connection of the hybrid ac/dc microgrids, which will be studied here. The grid synchronization algorithm starts to operate at 0.25s and the microgrid is connected to utility grid at 1s. It can be seen that the ac terminal voltage of the microgrid is able to track the utility grid voltage in a short time. It is also seen that no major overshoots of currents are observed. These prompts fast and smooth grid synchronization and connection operation.

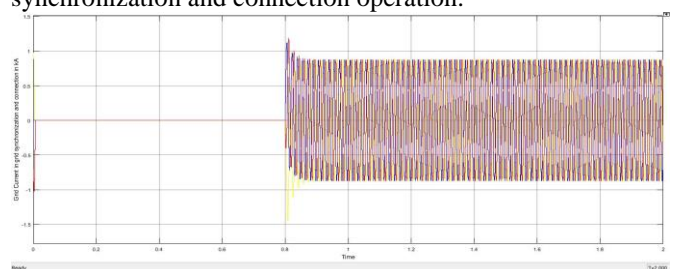

Fig 4.11- Grid Current in grid synchronization and connection using proposed method

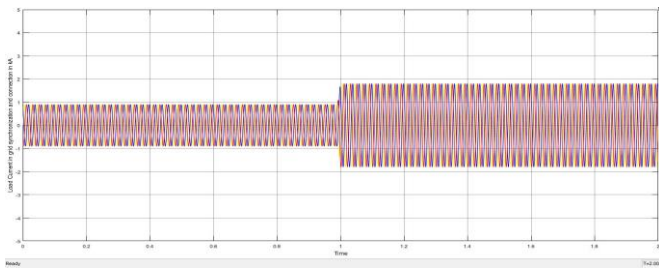

Fig 4.12- Load Current in grid synchronization and connection using proposed method

## 5. CONCLUSION

In this paper a model predictive control strategy of a microgrid with PV-wind-battery sources is proposed. A model predictive current and power (MPCP) scheme is developed to control the bidirectional dc-dc converter in the battery energy storage system (BESS), while a model predictive voltage and power (MPVP) method is proposed to control the ac/dc interlinking converter. They are used to coordinately control the dc/dc converter and ac/dc converter to smooth the renewable energy outputs and maintain dc- and ac-buses voltages. At the system level, a comprehensive energy management scheme is developed to ensure stable operation under different operation modes. The effectiveness of the proposed method is validated based on a pv-wind-battery system with real-world solar and wind profiles, showing better control capability and improved voltage quality in comparison with traditional method. It should be noted that, compared to traditional cascade control with PID regulators, additional measurements are needed for the proposed MPCP and MPVP approaches.

## REFERENCES

- [1] Yinghao Shan, Jiefeng Hu, Ka Wing Chan, Qing Fu, and Josep M. Guerrero, "Model Predictive Control of Bidirectional DC-DC Converters and AC/DC Interlinking Converters – A New Control Method for PV-Wind-Battery Microgrids", IEEE Transactions on Sustainable Energy, 1949-3029 (c) 2018 IEEE.
- [2] Seema and Bhim Singh, "Grid Synchronization Control for an Autonomous PV-Wind-Battery Based Microgrid", 978-1-5386-1138-8/18/©2018 IEEE.
- [3] Seema and Bhim Singh, "Control of Variable Speed WECS-PV-BES Based Microgrid with Grid Synchronization", 978-1-7281-0653-3/19/©2019 IEEE.
- [4] Farheen Chishti, Shadab Murshid, Bhim Singh, "An Intelligent Control for Synchronous Generator Based Wind-PV-Battery Microgrid System", 978-1-5386-9316-2/18/©2018 IEEE.
- [5] Habib Ur Rahman Habib, Shaorong Wang, Muhammad Tajamul Aziz, "PV-Wind-Battery Based Standalone Microgrid System with MPPT for Green and Sustainable Future", 978-1-7281-2658-6/19/ ©2019 IEEE.
- [6] Sambasivaiah Puchalapalli, S.K. Tiwari, Bhim Singh, and P.K. Goel, "A Microgrid Based on Wind Driven DFIG, DG and Solar PV Array for Optimal Fuel Consumption", IEEE Transactions on Industry Applications, 0093-9994 (c) 2020 IEEE.
- [7] Sivaprasad A, Kumaravel S, Ashok S., "Integration of Solar PV/Battery Hybrid System Using Dual Input DC-DC Converter", 2016 Biennial International Conference on Power and Energy Systems: Towards Sustainable Energy (PESTSE), 978-1-4673-6658-8/16/©2016 IEEE.
- [8] X. Liu, P. Wang, and P. C. Loh, "A hybrid ac/dc microgrid and its coordination control", IEEE Trans. Smart Grid, vol. 2, no. 2, 278-286, Jun. 2011.
- [9] A. Merabet, K. T. Ahmed, H. Ibrahim, R. Beguenane, and A. Ghias, "Energy management and control system for laboratory scale microgrid based wind-pv-battery," IEEE Trans. Sustain. Energy, vol. 8, no. 1, pp. 145–154, Jan. 2017.
- [10] N. Eghtedarpour and E. Farjah, "Power control and management in a hybrid ac/dc microgrid," in IEEE Trans. Smart Grid, vol. 5, no. 3, pp. 1494-1505, May 2014.
- [11] T. Ma, M. H. Cintuglu, and O. A. Mohammed, "Control of hybrid ac/dc microgrid involving energy storage and pulsed loads", IEEE Trans. Ind. Appl., vol. 53, no. 1, 567-575, 2017.
- [12] F. Nejabatkhah and Y. W. Li, "Overview of power management strategies of hybrid ac/dc microgrid", IEEE Trans. Power Electron., vol. 30, no. 12, 7072-7089, Dec 2015.
- [13] S. Vazquez et al., "Model Predictive Control: A Review of Its Applications in Power Electronics," IEEE Ind. Electron. Mag., vol. 8, no. 1, pp.16-31, 2014.
- [14] D. E. Quevedo, R. P. Aguilera, M. A. Perez, P. Cortes and R. Lizana, "Model Predictive Control of an AFE Rectifier With Dynamic References," in IEEE Trans. Power Electron., vol. 27, no. 7, pp. 3128-3136, July 2012.
- [15] J. Hu J. Zhu, and D. G. Dorrell, "Model predictive control of grid-connected inverters for PV systems with flexible power regulation and switching frequency reduction," IEEE Trans. Industry Applications, vol. 51, no. 1, pp. 587-594, Jan./Feb. 2015.
- [16] X. Li, H. Zhang, M. B. Shadmand, R. S. Balog, "Model predictive control of a voltage-source inverter with seamless transition between islanded and grid-connected operations," IEEE Trans. Ind. Electron., vol. 64, no. 10, pp. 7906–7918, 2017.